

Critical Speed Impact over the Pantograph-Catenary System's Behaviour

Gabriel Chiriac¹, Dumitru Cuciureanu² and Costica Nituca^{1*}

¹Technical University "Gheorghe Asachi" Iasi, Faculty of Electrical Engineering, Bd. D. Mangeron, nr. 21- 23, Iasi - 700050, Romania; gchiriac@tuiasi.ro, costica_nituca@yahoo.com

²"Q" SRL Iasi, Stradela Sf. Andrei nr.13, Iasi, Romania; office@qsrl.ro

Abstract

Objectives: To estimate the impact of the critical speed over the power collecting system for the electric trains. **Methods/Analysis:** Two models regarding the critical speed estimation related to the resonance phenomenon in the pantograph-catenary system are studied: firstly, by the differential equation of the contact point trajectory, and secondly by the maximum kinetic energy and the maximum potential energy over a span. Simulations for the pantograph-catenary interaction at train speeds close to the critical ones are done. Tests for different speeds were realised on an experimental stand. **Findings:** Records of the pantograph-catenary system's behavior show the influence of the critical speeds over the power collecting system and knowing the critical speeds on different trucks, it can be established the maximum speeds for the railway vehicles. It is to observe that the critical speed depends strongly on the mechanical tensions in the contact line and on the linear mass of the contact line. **Applications/Improvements:** Two relationships were established for the critical speed, one considering mechanical tension into the wire and another considering the length span. A test bench was developed for the pantograph-catenary researches.

Keywords: Critical Speed, Electric Trains, Pantograph-Catenary Interaction, Test Bench

1. Introduction

The pantograph-catenary system assures all along the track the power supply for the traction motor and for the equipment of the electric trains. The catenary system is used from the beginning of the electric railway, being an efficient system, but it has some drawbacks. As the train speed increases, the current collecting complexity increases too, due to some parameters such as: speed, train vibrations, catenary oscillations, aerodynamics, the catenary and pantograph construction, etc¹. The problems regarding the contact between the pantograph and the contact wire are largely studied in the literature with important results, considering the pantograph-catenary models and simulations^{1,2}. In³ it is assumed that the contact occurring between contact strip and contact wire is mostly influenced by the dissipated power at the contact due to arcing, friction effect and Joule effect. Thermal problems of the contact are also important, in order to

avoid the over-heating due to the high currents, being necessary to consider the analysis of the thermal model of electric contacts in electric rails system^{4,5}.

A limitation of the operational speed of trains is the wave propagation velocity on the contact wire C^6 , given by the relation $C = \sqrt{\left(\frac{\pi^2 E}{\rho L^2}\right) + (T/\rho)}$, where T is the tension of the contact wire, ρ is the contact wire mass per length unit, EI is the beam bending stiffness and L is the beam length. For high-speed catenaries, the second term of the relation dominates the critical speed and the first term becomes negligible. When the train speeds approach the wave propagation velocity of the contact wire, the contact between the pantograph and the catenary is harder to maintain due to the increasing in the amplitude of the catenary oscillations and to the bending effects. In order to avoid the deterioration of the contact quality, the current regulation imposes a limit to the train

*Author for correspondence

speed of $V = 0.7C^6$. Even for the foundation of the truck there are studies on the critical speeds, as in^{7,8}.

These critical speeds (above 200 m/s)⁷ are higher than for the contact wire but the results have direct application on estimates of ground vibrations induced by high-speed trains, and permit to evaluate the level of the additional loading factor to which high speed trains and tracks must be designed. Normally, train speed is less than 70% of the wave speed of the contact wire. If the vehicle's operation speed approaches to the wave speed of the contact wire, the probability of loss of contact is increased. Because of this loss of contact accompanying electric arcs between them, the current collector system becomes seriously damaged. Therefore, it is very important to maintain a stable contact force between the catenary and the collector plate of the pantograph. Because of the increasing interest in high-speed railway vehicles, the dynamic interaction between the catenary and the pantograph at high speeds has been studied extensively². There are also studies regarding unconventional methods to supply the electric traction vehicles¹⁰.

To study the pantograph-catenary interaction in real conditions, that is on trains, is difficult due to the high costs, the perturbation of the trains schedule, the necessity to adapt the current collecting system to the necessity of the data acquisition. This is why there are used test benches for the researches¹¹ using different systems for the pantograph-catenary interaction structure.

In this paper we realise an analysis of the critical speed for the pantograph-catenary system considering different relations to estimate it. It is analyzed the mathematical model of the interaction pantograph-catenary by simulations at the speeds of the train close to the critical speeds. On an experimental stand it is analyzed the interaction pantograph-catenary at critical speed.

2. Critical Speed Estimation

2.1 Critical Speed Estimation considering the Trajectory of the Contact Point

For the pantograph-catenary system it is important to estimate the differential equation of the trajectory of the contact point, with some simplified assumptions^{12,13}:

The pantograph-catenary structure is considered to be a system with elastic masses which are placed vertically, one above another; the contact force will determine the variation of the height of the contact point linked

to the kinetic energy of the masses. It is considered that the pantograph-catenary system has only one degree of freedom, which is in vertical direction;

There are neglected the dynamic forces due to the vibrations;

It is neglected the friction force between the contact wire and the skate of the pantograph;

It is neglected the aerodynamic influence (the air drag, the lateral wind);

The stiffness of the contact wire has a sinusoidal variation along a span;

The contact force due to the mechanical system of the pantograph (the spring) is constant.

Even considering these hypotheses, it is difficult to establish a mathematical model that reflects the phenomenon in its all complexity, because there are many parameters to estimate. Figure 1 presents the simplified model for the catenary and the pantograph.

The mathematical model is described by the next relationships¹⁴:

- For the vertical movement of the catenary:

$$m_c v^2 \frac{d^2 y}{dx^2} + b_c \frac{dy}{dx} = F_k - k_c y \quad (1)$$

For the vertical movement of the pantograph:

$$m_p v^2 \frac{d^2 y}{dt^2} = F_0 - F_k \quad (2)$$

From the equations (1) and (2) it results the differential equation of the trajectory of the contact point:

$$(m_c + m_p) v^2 \frac{d^2 y}{dx^2} + b_c \frac{dy}{dx} + k_c y = F_0 \quad (3)$$

Considering a sinusoidal variation over a span length for the mass of the catenary m_c and the stiffness coefficient k_c :

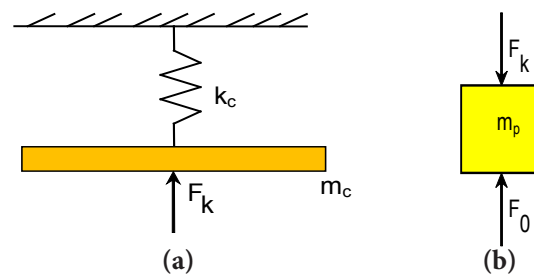

Figure 1(a). The catenary model. (b). The pantograph model.

$$m_c = m_{c0} \left(1 - a_m \cos \frac{2\pi}{L} x \right),$$

$$k_c = k_{c0} \left(1 - a_k \cos \frac{2\pi}{L} x \right) \quad (4)$$

where the coefficient of irregularity of the mass of the catenary α_m and the coefficient of irregularity of the stiffness of the catenary α_k are given by:

$$a_m = \frac{m_{\max} - m_{\min}}{m_{\max} + m_{\min}}, \quad a_k = \frac{k_{\max} - k_{\min}}{k_{\max} + k_{\min}}, \quad (5)$$

and

$$M = \left[m_{c0} \left(1 - a_m \cos \frac{2\pi}{L} x \right) + m_p \right]. \quad (6)$$

The differential equation (3) becomes:

$$Mv^2 \frac{d^2 y}{dx^2} + b_c \frac{dy}{dx} + k_{c0} \left(1 - a_k \cos \frac{2\pi}{L} x \right) y = F_0. \quad (7)$$

For the estimation of the critical speed it is proposed the solution^{14,15}:

$$y = a_0 + a_1 \cos \frac{2\pi}{L} x + b_1 \sin \frac{2\pi}{L} x \quad (8)$$

with:

$$\left. \begin{aligned} a_0 &= \frac{F_0}{k_{c0}} + \frac{a_k^2 F_0 \left(k_{c0} - Mv^2 \frac{4\pi^2}{L^2} \right)}{b_c^2 v^2 \frac{4\pi^2}{L^2} + \left(k_{c0} - Mv^2 \frac{4\pi^2}{L^2} \right)^2} \\ a_1 &= \frac{a_k^2 F_0 \left(k_{c0} - Mv^2 \frac{4\pi^2}{L^2} \right)}{b_c^2 v^2 \frac{4\pi^2}{L^2} + \left(k_{c0} - Mv^2 \frac{4\pi^2}{L^2} \right)^2} \\ b_1 &= \frac{a_k^2 F_0 b_c^2 v \frac{4\pi}{L}}{b_c^2 v^2 \frac{4\pi^2}{L^2} + \left(k_{c0} - Mv^2 \frac{4\pi^2}{L^2} \right)^2} \end{aligned} \right\} \quad (9)$$

Considering the damping coefficient of the catenary as $b_c = 0$, it results $b_1 = 0$, and the relation (8) becomes:

$$y = a_0 + a_1 \cos \frac{2\pi}{L} x \quad (10)$$

The formula for the critical speed v_k results considering the conditions when the coefficient a_0 and a_1 become infinite (and also y). These conditions are fulfilled if the denominator of the a_0 and a_1 from the equation (9) are zero¹⁴.

The relation for the critical speed is:

$$v_k = \frac{L}{2\pi} \sqrt{1 - \frac{1}{2} \alpha_k^2} \cdot \sqrt{\frac{k_{c0}}{M + m_{c0} \left(1 - \frac{\alpha_m \alpha_k}{2} \right)}}. \quad (11)$$

2.2 Estimation of the Critical Speed Considering the Kinetic Energy and the Potential Energy of the Contact Wire

Another possibility to analyze the critical speed is based on the analysis of the maximum kinetic energy, respective the maximum potential energy for a length L of a span for the vertical movement of the pantograph-catenary system, neglecting the influence of the dissipative forces. Thus, during the oscillations due to the force F_0 of the springs of the pantograph (which will lift the contact wire), the contact wire could be considered to have a parabola shape.

Thus, the total kinetic energy E_c corresponding to the vertical movement of the catenary mass m_{c0} on the span length L , will be depicted as,

$$E_c = \frac{1}{2} 2 \int_0^L \left(\frac{dh}{dt} \right)^2 \frac{d}{dx} \quad (12)$$

where dh/dt represents the speed of motion of the mass of the catenary $m_{c0} dx$ at the distance x from the centre.

According to the Figure 2, for the lifting h of a point from the contact line placed at the distance x from the middle of the span:

$$h = h_0 \left(1 - \frac{4}{L^2} x^2 \right) \quad (13)$$

The oscillation of the contact line is considered to be a harmonic one¹⁶:

$$h_0 = h_{0\max} \sin \omega t \quad (14)$$

where $h_{0\max}$ is the amplitude of the oscillation in the middle of the span.

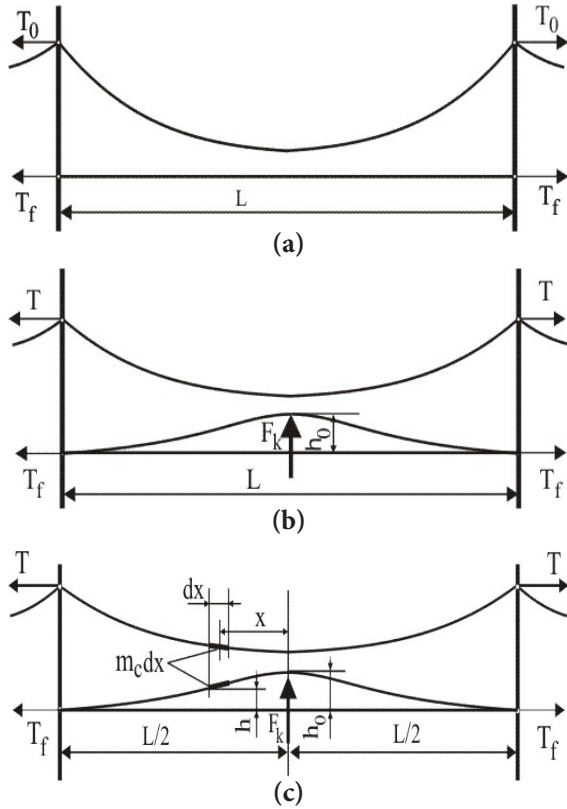

Figure 2. The forces acting on the catenary. (a) The catenary at standstill. (b) The shape of the catenary when the pantograph is on the middle of the span. (c) Catenary analysis for a distance x from the middle of the span.

It is considered that the value of the maximum kinetic energy occurs when the contact wire passes through horizontal position $\omega t = k\pi$, ($k = 0, 1, 2, \dots$). In these conditions, the maximum kinetic E_{cmax} energy equation will be written as:

$$E_{cmax} = \int_0^{L/2} m_{c0} \left(\omega h_{0max} \left(1 - \frac{4}{L^2} x^2 \right) \right)^2 dx = \frac{4}{15} m_{c0} L h_{0max}^2 \omega^2 \quad (15)$$

The maximum potential energy corresponds to the maximum value of the catenary displacement, which is for $\omega t = \pi/2 + k\pi$. If the force of motion F_0 is a function of h_0 , the maximum potential energy will be:

$$E_{pmax} = \int_0^{h_{max}} F_0 dh_0 \quad (16)$$

There are considered two situations:

$$a) F_0 = h_0 \frac{4(T_0 + T_f)}{L} \frac{1}{\xi}, \quad (17)$$

where ξ is a damping coefficient due to the sectional static stiffness.

For $T = T_0$ it is established as $\xi = 1$.

$$b) F_0 = \frac{h_0}{y_0}, \quad (18)$$

where $y_0 = (\xi \cdot L) / (4 \cdot (T_0 + T_f))$ is considered constant, independent of F_0 .

For the first case, the potential energy relationship can be written in the form of:

$$E_{pmax} = \frac{4(T_0 + T_f)}{L} \frac{1}{\xi} \int_0^{h_{max}} h_0 dh_0 = \frac{2(T_0 + T_f)}{\xi L} h_{0max}^2, \quad (19)$$

and for the second case:

$$E_{pmax} = \frac{1}{y_0} \int_0^{h_{max}} h_0 dh_0 = \frac{1}{2y_0} h_{0max}^2 \quad (20)$$

Taking into account the equations (15) and (19), and the equations (15) and (20), it results

$$\frac{4}{15} m_{c0} L h_{0max}^2 \omega^2 = \frac{2(T_0 + T_f)}{\xi L} h_{0max}^2 \quad (21)$$

and

$$\frac{4}{15} m_{c0} L h_{0max}^2 \omega^2 = \frac{1}{2y_0} h_{0max}^2 \quad (22)$$

with $\omega = \sqrt{\frac{15(T_0 + T_f)}{2 \xi m_{c0} L^2}}$, and $\xi = 1$.

The frequency of the free oscillations can be described by:

1. Considering mechanical tension into the wires:

$$v_{(a)} = \frac{0,436}{L} \sqrt{\frac{T_0 + T_f}{m_{c0}}} \quad (23)$$

2. Considering the length of the span:

$$v_{(b)} = 0,218 \sqrt{\frac{1}{m_{c0} L y_0}} \quad (24)$$

Under these circumstances, critical speed can be described with the following relation:

$$v_{cr(a)} = L v_{(a)} = 0,436 \sqrt{\frac{T_0 + T_f}{m_{c0}}}, \quad (25)$$

or

$$v_{cr(b)} = L v_{(b)} = 0,218 \sqrt{\frac{L}{m_{c0} y_0}} \quad (26)$$

Since the stiffness from a span to another are different, (it is minimum in the front of the pillars and maximum in the middle of the span), when the pantograph passes under the contact wire, especially at high speed, the wire is influenced by a mass force given by the alternative motions of the pantograph, resulting an oscillation of the wire¹⁶. In the case of the sinusoidal trajectory, for the low speed of the trains, the force of inertia is variable between minimum at the front of the pillars and maximum in the middle of the span. Considering the same simplified assumptions as above, in Figure 3 it is presented a model¹⁷⁻¹⁹, for the interaction between the pantograph and the catenary.

The mechanical parameters characterizing the pantograph-catenary interaction in Figure 3 have periodic variations along a span and can be described by the relationships (27), which represent a Fourier series of the parameters of the catenary, considering the second and the third harmonics:

$$\left. \begin{aligned} m_c(t) &= m_{c0} + \sum_{i=1}^3 m_{ci} \cos\left(\frac{2i\pi}{L}x(t)\right) \\ b_c(t) &= b_{c0} + \sum_{i=1}^3 b_{ci} \cos\left(\frac{2i\pi}{L}x(t)\right) \\ k_c(t) &= k_{c0} + \sum_{i=1}^3 k_{ci} \cos\left(\frac{2i\pi}{L}x(t)\right) \end{aligned} \right\} \quad (27)$$

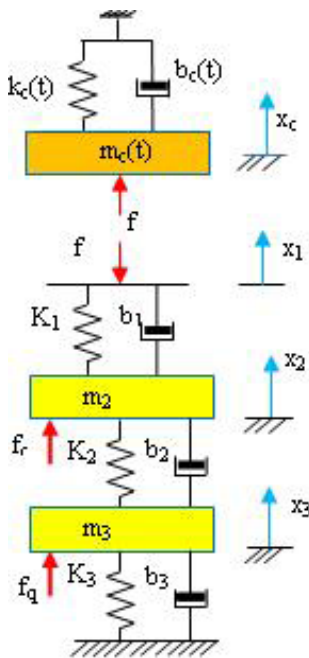

Figure 3. The model of the pantograph-catenary interaction.

The contact force acting on the elastic system pantograph-catenary can be described by¹⁷:

$$f = \max\{k_1(x_2 - x_1) + b_1(\dot{x}_2 - \dot{x}_1) \ 0\} \quad (28)$$

During the transfer of the electric current from the contact wire to the pantograph, it is considered that the pantograph is in permanent contact with the wire $x_1 \equiv x_c$ and thus, the contact force f will have positive values. In this context, according to the Figure 3, it can be written:

$$\left. \begin{aligned} m_c(t)\ddot{x}_1 + b_c(t)\dot{x}_1 + k_c(t)x_1 &= k_1(x_2 - x_1) + b_1(\dot{x}_2 - \dot{x}_1) \\ m_2\ddot{x}_2 + b_2\dot{x}_2 + k_2x_2 &= k_2x_3 + b_2\dot{x}_3 + f_c(t) - k_1(x_2 - x_1) + b_1(\dot{x}_2 - \dot{x}_1) \\ m_3\ddot{x}_3 + (b_2 + b_3)\dot{x}_3 + (k_2 + k_3)x_3 &= k_2x_2 + b_2\dot{x}_2 + f_q(t) \end{aligned} \right\} \quad (29)$$

where $y(t) = f(t)$ is the contact force.

3. Simulations of the Pantograph-Catenary System for Critical Speeds

For a comparative analysis of the critical speeds established by the relations (11) and (26), there are considered the parameters with the following values: $m_{c0} = 195$ kg, $m_p = 17.1$ kg, $k_{c0} = 7000$ N/m, $\alpha_m = 0.95$, $\alpha_k = 0.95$, $T_o = T_f = 20$ kN, $h_o = 0.35$ m, $L = 60$ m. The speeds are denoted as v_{k1} for the relation (11), v_{k2} for the relation (26).

The maximum values of the critical speeds are estimated as: $v_{k1max} = 73.92$ m/s (266 km/h) and $v_{k2max} = 69.44$ m/s (233.7 km/h) shown in the Figure 4.

It is to observe a low difference between the critical speeds values, resulting that the vehicle could run safely on such a contact line with lower speeds than the critical

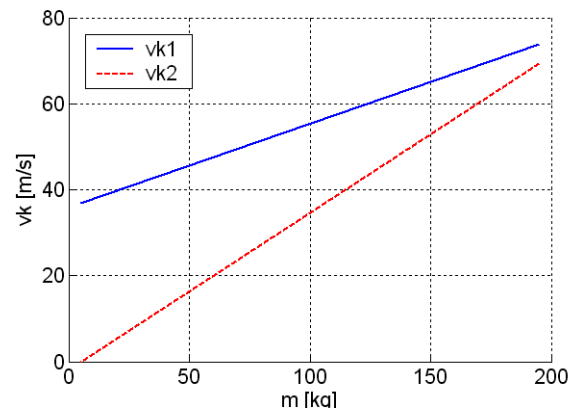

Figure 4. Variation of the critical speed V_k depending on the linear mass m_c .

one. It has considered as reference speed the values for v_{k1} the Equation (11). So, it has been computed the errors for the speed v_{k2} which uses the Equation (26). From the errors computation it results for formula (26) the error $\varepsilon_1 = \pm \frac{v_{k2} - v_{k1}}{v_{k1}} \cdot 100\% = -6.06\%$, which is a low value.

It is also to observe that the critical speed depends strongly on the mechanical tensions in the contact line and on the linear mass of the contact line. Thus, an increasing of the tension will result in an increase of the critical speed. The critical speed also depends on inverse ratio with the mass of the catenary. The oscillations of the contact line at the critical speed can be analyzed considering the model in Figure 3, the relations in (27) and the parameters with the following

values: $m_{c0} = 195kg$, $m_{c1} = 100kg$, $m_{c2} = 20kg$, $m_{c3} = 5kg$, $b_{c0} = 240Nm^{-1}s$, $b_{c1} = 240Nm^{-1}s$, $b_{c2} = 50Nm^{-1}s$, $b_{c3} = 12Nm^{-1}s$, $k_{c0} = 7000Nm^{-1}s$, $k_{c1} = 3360Nm^{-1}s$, $k_{c2} = 650Nm^{-1}s$, $k_{c3} = 160Nm^{-1}s$, $m_2 = 7,6kg$, $m_3 = 9,5kg$, $b_1 = 5000Nm^{-1}s$, $b_2 = 20Nm^{-1}s$, $b_3 = 5000Nm^{-1}s$, $k_1 = 10^5 Nm^{-1}s$, $k_2 = 3421Nm^{-1}s$, $k_3 = 0$, $F_0 = 100N$ [17].

Figure 5 presents the variation of the parameters of the contact line along the truck for a speed of $v = 100$ km/h, (below the critical ones). The stiffness of the contact line k_c varies between a minimum of 4134 N/m·s and a maximum of 11170 N/m·s; the damping coefficient is between the 38.11Nm⁻¹s and 542Nm⁻¹s and the catenary mass oscillates between 110 kg and 320 kg. These variations have constant amplitudes all along the truck and it can be

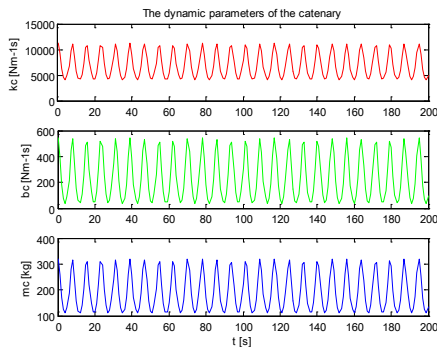

Figure 5. Parameters variation of the contact line for a speed of $v = 100$ km/h.

considered that for this speed of the vehicle there are no problems regarding the power collecting on the vehicle.

Figure 6 presents the variation of the parameters of the contact line on the same truck side. The speed of the pantograph is $v = 150$ km/h, which is below the critical speed. The maximum values for the stiffness coefficient of the contact line k_c oscillate between the 9954 Nm⁻¹s and 11170Nm⁻¹s and a minimum of 4134Nm⁻¹s .

The damping coefficient of the catenary b_c oscillates with values between 452.1Nm⁻¹s and 542Nm⁻¹s, with a minimum of 38.04Nm⁻¹s . The mass of the catenary has maximum values of 283.1 kg and 320 kg and a minimum of 110 kg. In these conditions it results that the contact line has relatively constant amplitudes and the energy transfer from the line on the vehicle is achieved in good conditions.

Figure 7 presents the variation of the parameters of the contact line on the same truck side. The pantograph has the critical speed given by the relation

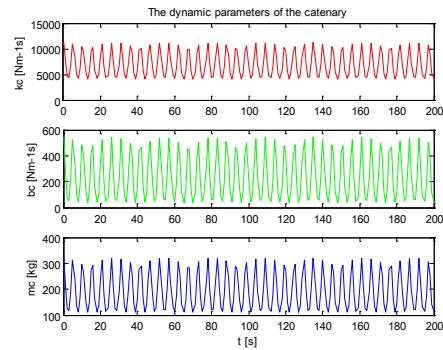

Figure 6. Parameters variation of the contact line for the speed $v = 150$ km/h.

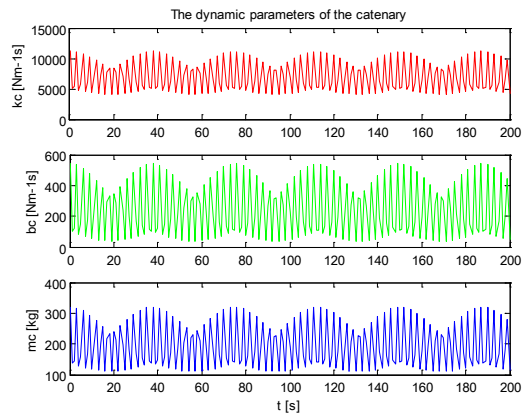

Figure 7. Parameters variation of the contact line for the speed $v_{k1max} = 266$ km/h.

(8), $v_{k1max} = 266$ km/h. From the graphics it results a variation of the amplitudes with a period time of $T = 38$ s.

The stiffness coefficient of the contact line k_c has the same maximum and minimum ($11170Nm^{-1}s$ and $4134Nm^{-1}s$) for $t = 18$ s, 56 s, 94 s, 132 s a.s.o.. For a period of time of $T = 38$ s it has a different maximum and minimum, which are $8251Nm^{-1}s$ and $4132Nm^{-1}s$. The damping coefficient b_c has the maximum and minimum as above ($542Nm^{-1}s$ and $38.04Nm^{-1}s$) for the same moments in time $t = (18s, 56s, 94s, 132s)$. Also, for a period time of $T = 38$ s, it has maximum and minimum values of $327.1Nm^{-1}s$ and $38.13Nm^{-1}s$. The mass of the catenary has also a variation with the period time $T = 38$ s, with values of 231.7 kg and 110.1 kg.

Considering these oscillations, the movement of the pantograph could not be considered being safe, because at any of these moments it could appear detachments between the collector head and the contact line, with negative effects in power collecting on the vehicle. With the above parameters, considering the model in Figure 3 and the relations (27-29), there are estimated the variation of the contact force, see Figure 8, and the variation of the contact point, Figure 9, for a vehicle speed of 100 km/h and a critical speed of $v_{k1max} = 266$ km/h. In Figure 8(a) and 8(b)

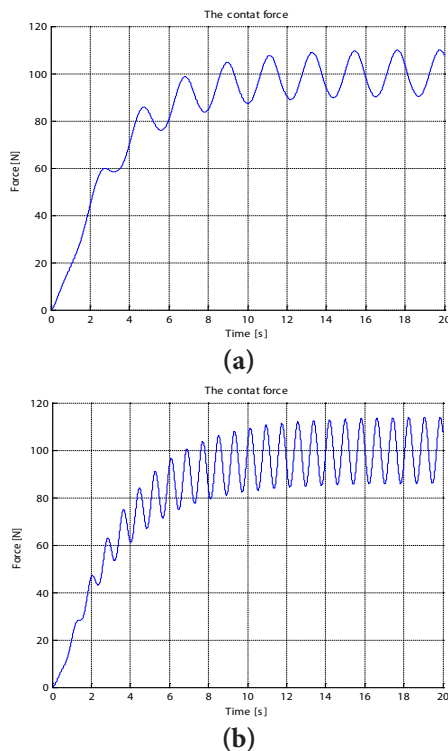

Figure 8. Variation of the contact force. (a) $v = 100$ km/h; (b) $v_{k1max} = 266$ km/h.

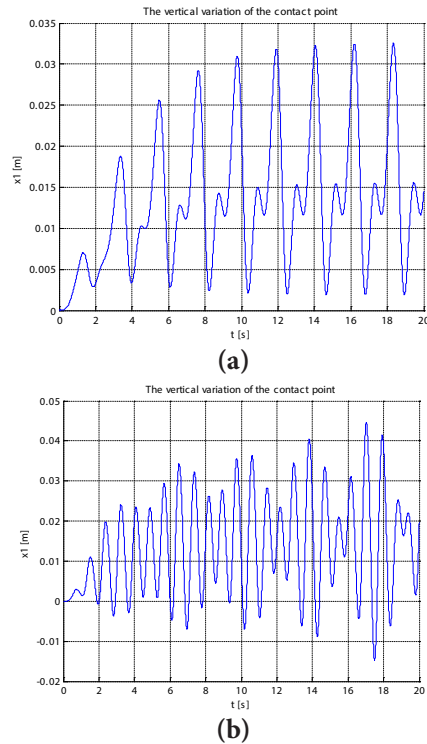

Figure 9. Variations of the contact point: (a) $v = 100$ km/h; (b) $v_{k1max} = 266$ km/h.

it can be observed that the contact force oscillates around the values of 100 N, with a maximum of $F_{max} = 113.2$ N and a minimum of $F_{min} = 85.78$ N.

(a) presents the lift of the contact point for a speed of the vehicle of 100 km/h, with positive variations between a minimum of $x_{imin} = 0.002$ m and a maximum of $x_{imax} = 0.032$ m. Figure 9(b) shows the variation of the contact point for the critical speed of 266 km/h. In this case there is a lift of 0.01 m at $t = 1.5$ s, and after that it appears some oscillations with negative amplitudes.

Thus, the contact point has a minimum of $x_{imin} = -0.014$ m and a maximum of $x_{imax} = 0.044$ m. These negative values give the detachments of the collector head from the contact line with consequences in power collecting interruptions on the vehicle.

4. Experimental Analysis of the Pantograph-Catenary System at Critical Speed

An experimental stand was developed in order to study the pantograph-catenary system's behaviour at different speeds shown in Figure 10.

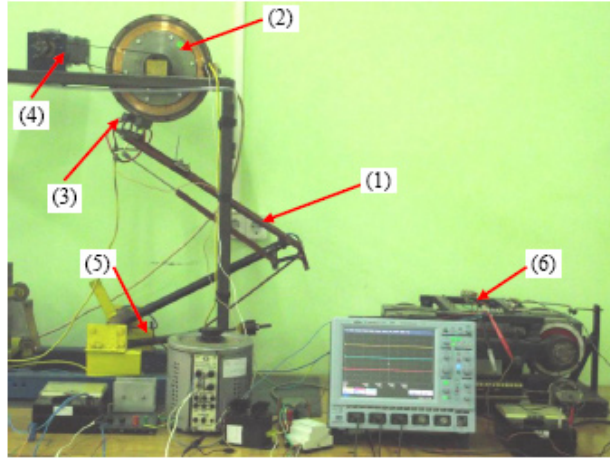

Figure 10. Pantograph-catenary experimental stand.

An asymmetrical pantograph, 1. At a scale of 1:4 as regarding a real system (a real pantograph used on an electric locomotive and the distance between the two consecutive droppers) is used. A rotating copper disk, 2. With a diameter of $\Phi_{Cu} = 477$ mm and a thickness of $g_{Cu} = 8$ mm is used as a contact line. 3. The rotating disc is in contact with the graphite skate. The disc has an eccentricity and it is elastically fixed in order to reproduce the oscillations of the contact line.

The disc is droved by an electric motor, 4. Controlled with a static converter for linear speeds v_d corresponding from 0 to 75 km/h. For the scale 1:4 the maximum corresponds to a train speed of 300 km/h. It is to mention that the pantograph has the classical mechanical lifting (springs) system, 5. Used for the main lifting force. The pantograph model has a low inertia, a good lateral stability, a constant contact pressure for a specific height and a low wear of the carbon skate. As load it is used a model bogie, 6. With two D.C. traction motors. The speed of the vehicle is simulated by the rotation of the copper disk. Thus, for a speed of 100 km/h, the disk rotates with a speed of 1109.1 rot/min and for 266 km/h the disk rotates with 2959.7 rot/min. The disk is mounted with an eccentric axle in order to reproduce closely the real contact line between two suspension points. Thus, it will result a sinusoidal trajectory of the contact point.

With the aim of recording the current and voltage waveforms, a digital oscilloscope type LeCroy Wave Surf 400 has been used. On the first channel (C1) the load current has been recorded using a current probe Hall LA 55P type, with a transform ratio of 50A/50 mA. A resistance standard of 100 Ω was used, which, finally, resulted in a

voltage ratio of 50A/5V. The voltage at the terminals of the traction motor was recorded on channel 2 (C2). The voltage signal was acquired by a voltage probe Hall LV 100-100 type, with a voltage ratio of 100V/50mA. Using a 100 Ω standard resistance it results in a transform ratio of 100V/5V. The waveform of the contact voltage was recorded directly on channel 3 (C3).

Figure 11 shows the experimental waveforms for current and voltage for the speed of 100 km/h. In this case the waveforms haven't important variations: there are no important variations of the load current (Channel C1) and the voltage on the traction motor (Channel C2) and the voltage drop between the pantograph and the contact line (Channel C3).

These waveforms have been recorded at the speed of 100 km/h, lower than the critical speed of 266 km/h, hence, at this speed; there are no risks of detachments of the collector head from the disk.

Figure 12 shows the experimental waveforms for current and voltage for the critical speed of $v_{kmax} = 266$ km/h. In this case the waveforms have important oscillations. It can be observed that there is no variation in the load current (Channel C1) but there are variations of the voltage of the motor (Channel C2). Also, it can be notice that the voltage across the pantograph and the contact line (Channel C3) has important variations, between 250 mV and almost 2 V. Hence, at the same value of the load

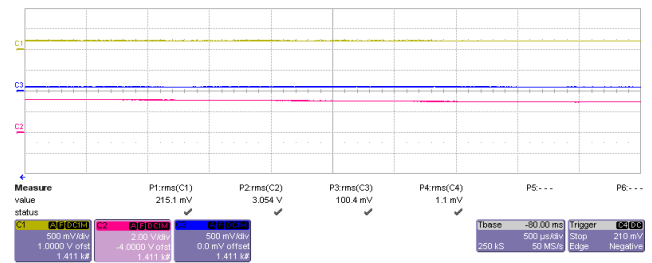

Figure 11. Experimental waveforms for current and voltage for $v=100$ km/h.

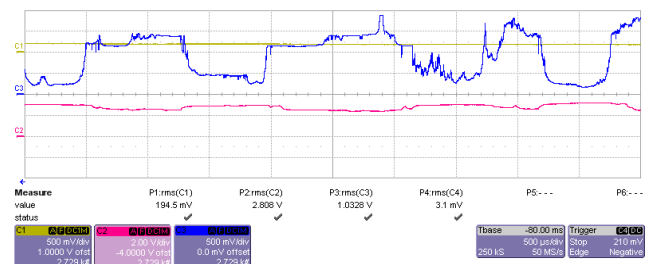

Figure 12. Experimental waveforms for current and voltage at $v_{kmax} = 266$ km/h.

current, the contact resistance between the pantograph and the contact line increases and that means power losses at high values.

The contact voltage has large variations because of the detachments between the collector head and the disk with the risk of occurring an electric arc between them. These tests show the influence of the critical speed over the pantograph-catenary system's behaviour.

5. Conclusions

In order to provide a permanent contact between the collector head and the contact line the pantograph has to trace closely the contact line. Because of the contact force of the pantograph the contact wire is lifted up, and, in combination with the vehicle's movement, it results a movement of the deformation of the contact line. This longitudinal deformation of the contact line propagates along the truck as elastic waves. As the speed of the vehicle increases, there also increases the speed of the propagation of the deformation, approaching the critical speed of the catenary.

This paper presents an analysis of critical speeds considering some models regarding the critical speed estimation on the pantograph-catenary system related to the resonance phenomenon in the pantograph-catenary system. A comparative analysis is also presented for the critical speed depending on the mechanical tensions in the contact wire and its mass. It was analyzed the mathematical model of the interaction pantograph-catenary and were performed simulations at the speeds of the train close to the critical speeds. The variations of the contact force, the damping coefficient of the catenary, the stiffness coefficient along a span of the catenary, and the mass of the catenary distributed along a span are analysed as simulations results. On an experimental stand it is analyzed the interaction pantograph-catenary at critical speed. Records of the pantograph-catenary system's behaviour show the influence of the critical speeds over the power collecting system and knowing the critical speeds on different trucks, it can be established the maximum speeds for the railway vehicles.

6. References

1. Rachid A. Pantograph Catenary Control and Observation using the LMI Approach. 50th IEEE Conference on Decision and Control and European Control Conference (CDC-ECC); Orlando, FL, USA. 2011. p. 2287–92.
2. Collina A, Bruni S. Numerical simulation of pantograph-overhead equipment interaction: Vehicle system dynamics. *Int J Veh Mech Mobility*. 2002; 38(4):261–91.
3. Walters S, Rachid A, Mpanda A. On modelling and control of pantograph catenary systems. International Conference on Pantograph Catenary Interaction Framework for Intelligent Control (PACIFIC); Amiens, France. 2011 Dec 8–9.
4. Plesca A. Thermal analysis of a traction system with double conducting points in steady state conditions. *Electr Power Syst Res*. 2013; 97:126–32.
5. Plesca A. Thermal analysis of sliding electrical contacts with mechanical friction in steady state conditions. *Int J of Thermal Sciences*. 2014; 84:125–33.
6. Jorge A, Joao P, Manuel P, et al. A computational procedure for the dynamic analysis of the catenary-pantograph interaction in high-speed trains. *J Theor Appl Mech*. 2012; 50(3):681–99.
7. Dimitrova Z, Varandas JN. Critical velocity of a load moving on a beam with a sudden change of foundation stiffness: Applications to high-speed trains. *Comput Struct*. 2009; 87: 1224–32.
8. Huang H, Chrismer S. Discrete element modelling of ballast settlement under trains moving at critical speeds. *Constr Build Mater*. 2013; 38:994–1000.
9. Lee JH, Kim YK, et al. Performance evaluation and design optimization using differential evolutionary algorithm of the pantograph for the high speed train. *J Mech Sci Technol*. 2012; 26(10): 3253–60.
10. Plesca A. Electric arc power collection system for electric traction vehicles. *International Journal of Electrical Power and Energy Systems*. 2014; 57:212–21.
11. Bruni S, Bucca G, et al. Numerical and hardware-in-the-loop simulation of pantograph-catenary interaction. Pantograph Catenary Interaction Framework for Intelligent Control Conference (PACIFIC); Amiens, France. 2011 Dec 8–9.
12. Nituca C. Probleme de captare a curentului in tractiunea electromecanica [Ph.D. thesis]. Romania: Romanian, Technical University of Iasi; 2003.
13. Cantemir CG. Cercetari privind dinamica pantografelor asimetrice, (in Romanian) [Ph.D thesis]. Romania: Technical University of Iasi; 1997.
14. Pasca N, Scorțeanu R. Influența diversilor parametri asupra traiectoriei punctului de contact dintre pantograf și catenars, la viteze mari de circulație, studiată pe calculatorul analogic (in Romanian). *Revista Transporturilor și Telecomunicações*. 1974; 4:210–5.
15. Chen Z, Jian Z, Jidong H. The evaluation of the electromagnetic emission from high-speed railway by pantograph and network parameters. Asia-Pacific Conference on Environmental Electromagnetics (CEEM'2000); Shanghai, China. 2000 May 3-7. p. 279–84.

16. Turos G. Vehicule neconvenționale de tractiune feroviara (in Romanian). Vol. 1. Timisoara: Traian Vuia IP, (editors). 1976. p. 42.
17. Cho YH. Numerical simulation of the dynamic responses of railway overhead contact lines to a moving pantograph, considering a nonlinear dropper. J Sound Vib. 2008; 315:433–54.
18. Mokrani N, Rachid A. A robust control of contact force of pantograph-catenary for the high-speed train. European Control Conference; Zurich. 2013 Jul 17-19. p. 4568–73.
19. Pisano A, Usai E. Contact force estimation and regulation in active pantographs: An algebraic observability approach. Proceedings of 46th IEEE Conference on Decision and Control; New Orleans, Louisiana. 2007 Dec 12–14. p. 4341–6.

Nomenclature

- | | |
|--|--|
| <p>b_c – Damping coefficient of the catenary;</p> <p>E_c – Kinetic energy of the catenary;</p> <p>E_{cmax} – Maximum kinetic energy of the catenary;</p> <p>E_{pmax} – Maximum potential energy of the catenary;</p> <p>F_k – Contact force between the collector head and the contact wire;</p> <p>F_0 – Force of the resort of the pantograph;</p> <p>$f_q(t)$ – Control force on the lower arm of the pantograph;</p> <p>$f_c(t)$ – Control force on the upper arm of the pantograph;</p> <p>h – Vertical amplitude of the contact wire;</p> | <p>h_0 – vertical amplitude of the contact wire in the middle of the span;</p> <p>h_{0max} – maximum vertical amplitude of the contact wire in the middle of the span;</p> <p>k_c – Stiffness coefficient along a span of the catenary;</p> <p>k_{c0} – Medium stiffness coefficient;</p> <p>L – Distance between two successive suspensions of the catenary;</p> <p>M – The sum of the equivalent mass of the pantograph and of the contact wire;</p> <p>m_p – Total mass of the pantograph;</p> <p>m_{c0} – Linear mass of the contact line;</p> <p>m_c – Mass of the catenary distributed along a span;</p> <p>T_0 – Mechanical tension into the messenger wire in standstill;</p> <p>T – Mechanical tension into the messenger wire during the pantograph movement;</p> <p>T_f – Mechanical tension into the contact wire;</p> <p>v – Train speed; $b_c(t)$</p> <p>v_k – Critical speed of the pantograph–catenary system;</p> <p>γ_0 – Cross static elasticity of the contact wire;</p> <p>α_m – Coefficient of irregularity for the mass of the catenary;</p> <p>α_k – Coefficient of irregularity for the stiffness of the catenary;</p> <p>$v(a), v(b)$ – Free oscillation frequency for the catenary.</p> |
|--|--|